



■ Vers. N46



■ Vers. N46



■ Vers. 272+291+189



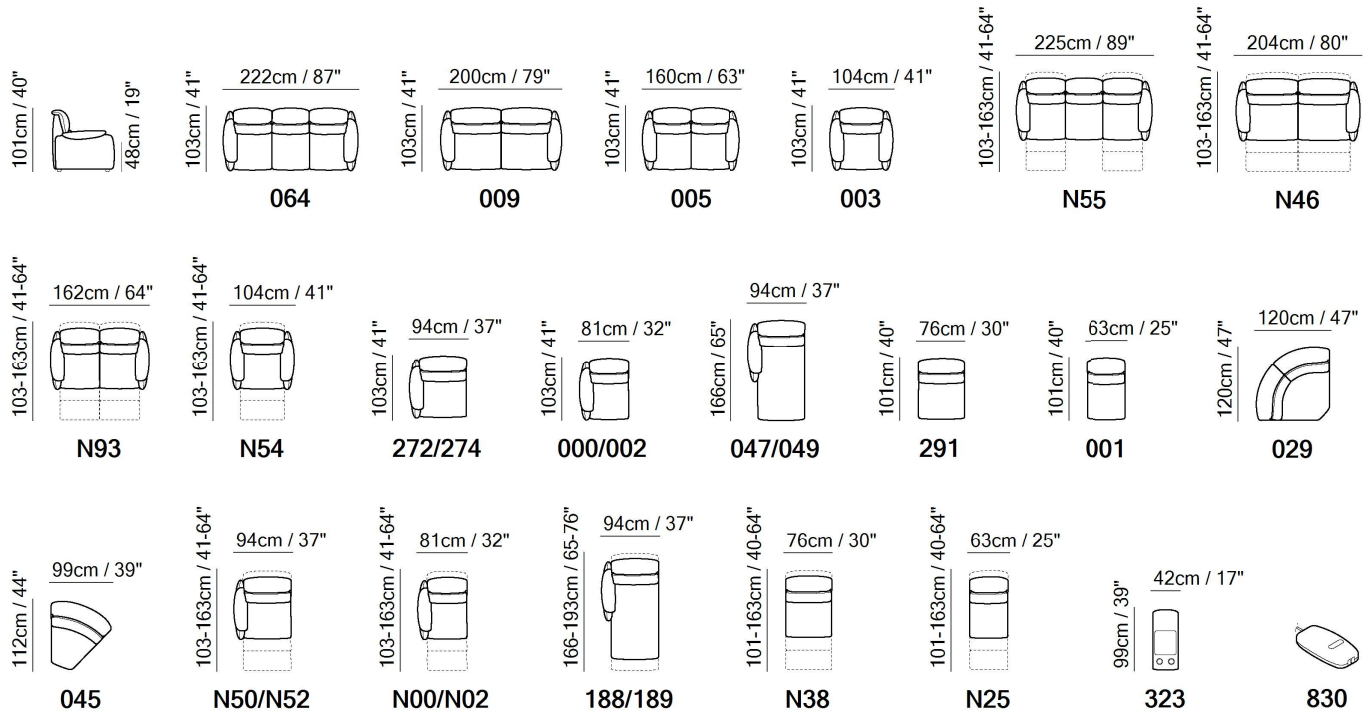

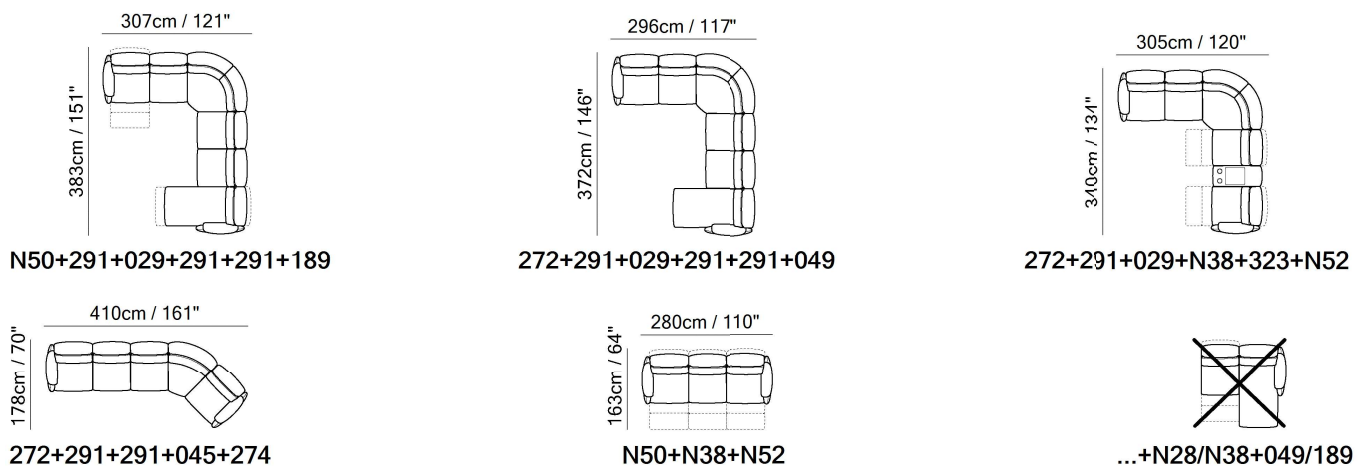

SCHEMATICS



COMPOSITION EXAMPLES



TECHNICAL INFORMATION

	COVERING	Leather <input checked="" type="checkbox"/>	Soft Cover <input checked="" type="checkbox"/>		
	FILLING	Arms <input type="checkbox"/> Fiber <input checked="" type="checkbox"/> Foam <input type="checkbox"/> Feather/Fiber Mix <input type="checkbox"/> Feather	Seat cushion <input type="checkbox"/> Fiber <input checked="" type="checkbox"/> Foam <input type="checkbox"/> Feather/Fiber Mix <input type="checkbox"/> Feather	Back cushion <input type="checkbox"/> Fiber <input checked="" type="checkbox"/> Foam <input type="checkbox"/> Feather/Fiber Mix <input type="checkbox"/> Feather	
	COMFORT	Firm Comfort <input checked="" type="checkbox"/>	Standard Comfort <input checked="" type="checkbox"/>		
	FUNCTION	Bed <input type="checkbox"/>	Electric motion <input checked="" type="checkbox"/>	Motion <input checked="" type="checkbox"/>	Recliner <input checked="" type="checkbox"/> Sliding <input type="checkbox"/>
	VISUAL APPEARANCE*	Low <input checked="" type="checkbox"/>	Medium <input type="checkbox"/>	High <input type="checkbox"/>	
	LEGS	Upholstered <input type="checkbox"/>	Castors <input type="checkbox"/>	Metal <input type="checkbox"/>	Plastic <input type="checkbox"/> Wood <input type="checkbox"/>

VISUAL APPEARANCE

The product may reveal various wrinkles due to the combination of Elasticity of the covering, characteristics of the interior construction and the design of the product.



Products with Visual Appearance listed as High or Medium would require higher degree of care, where seats and back cushions may require fluffing and plumping more often than Products with Visual Appearance listed as Low.

NOTES

- Available in leather (TG only) or fabric.
- FABRIC: In fabric contrast welt (or any another decorative detail such as a band under arm cushion) can be made either in same category fabric or in leather with any color of Le Mans (only).
- CUBICOMFORT™ Triple-Motion Technology is a registered trademark. It denotes a set of independent motion systems that activate the various elements of the sofa (seat, backrest, headrest and footrest) allowing each person to adjust their position of absolute comfort to the millimeter.
- Mech. 1: All in One Power Reclining mechanism simultaneously reclines the back and seat and footrest that allows you to reach a horizontal position for unlimited relaxation.
- Mech. 2: Power Lumbar Support allows you to adjust the lower part of the backrest by increasing or decreasing the pressure for a better back support.
- Mech. 3: Power Adjustable Headrest which allows you to recline the headrest forward with millimetric precision and reach a perfect relaxation position for great comfort.
- Equipped with satin label that is intended to indicate the position of the control panel.
- Functions are operated by a three-button power switch located hidden on the seat cushion side.
- A battery pack can be ordered with its own version code 830. For order entry please use XX for category and XXX for cover code. In order to optimize the duration of the battery, it is suggested to order one per each motion seat.